

MLA & MLA-T

Articulated loader range



Handling your world

Founded over 60 years ago by the Braud family, the Manitou Group now operates worldwide. A world-leader in all-terrain material handling, the Group designs, manufactures, distributes and services equipment for construction, agriculture and industries.

The Group's product ranges include: all-terrain fixed, rotating and heavy-load telehandlers; all-terrain, semi-industrial and industrial masted forklift trucks; wheel or track skid-steer loaders; articulated loaders; access platforms; truck-mounted forklifts; warehousing equipment; and attachments.

Through its iconic brands - Manitou, Gehl and Mustang by Manitou- and its worldwide network of 1,500 dealers, the Group offers the best solutions to create optimum value for its customers.

Headquartered in France, the Group registered a revenue in 2018 of 1.900 billion euros in 140 countries and employs 4,400 people, all strongly focused on satisfying customers.

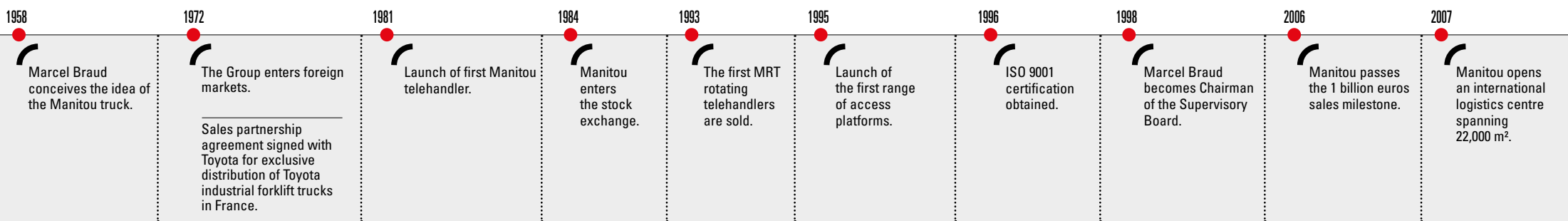

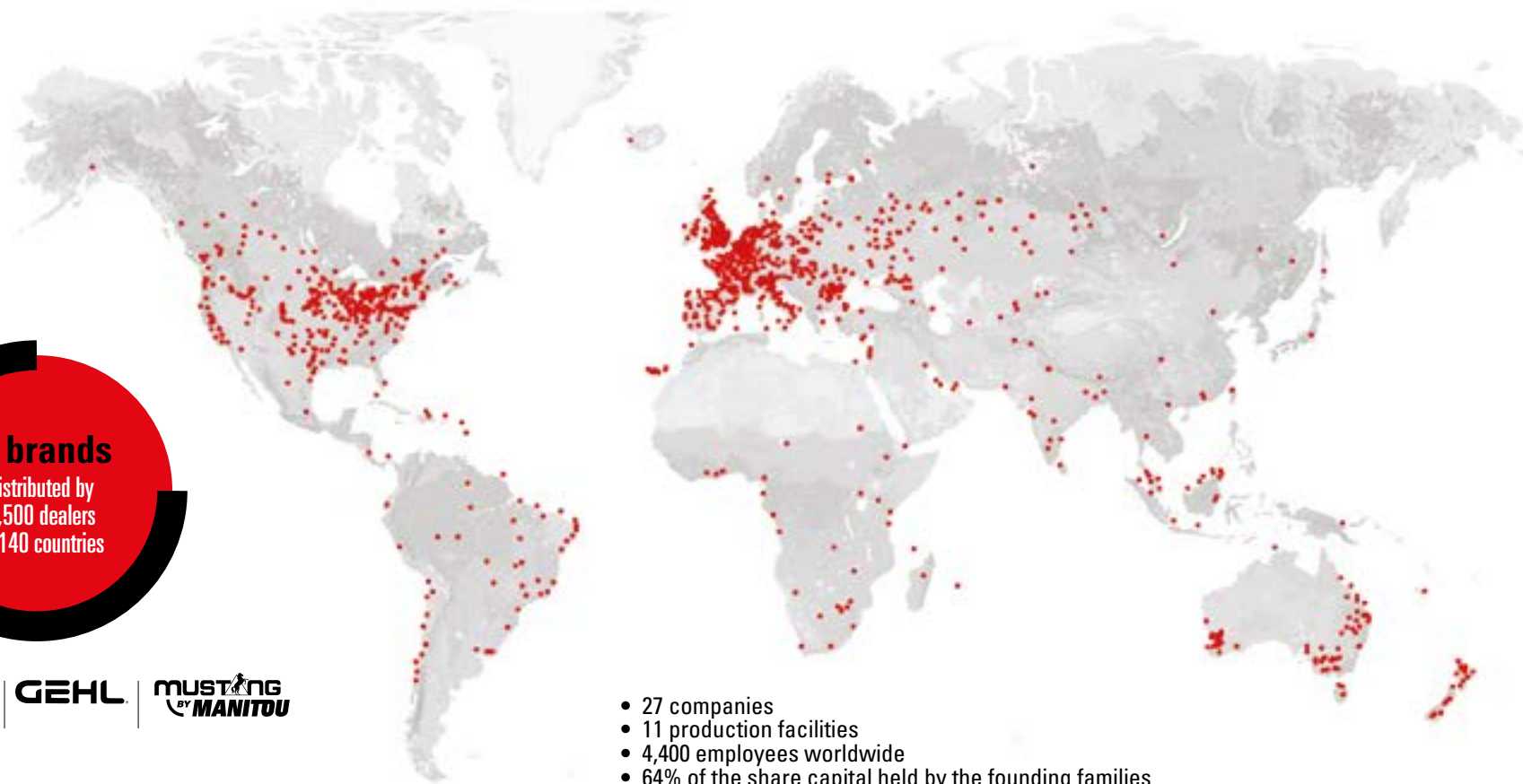

3 brands
distributed by
1,500 dealers
in 140 countries



- 27 companies
- 11 production facilities
- 4,400 employees worldwide
- 64% of the share capital held by the founding families
- 78% of revenue comes from foreign markets
- 1.900 billion euros of turnover in 2018

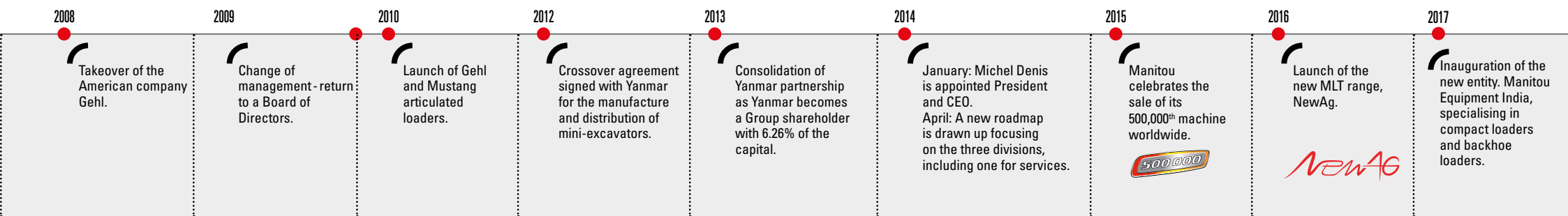





MLA-T 533 + CAB bucket

Up to **5.20m**
Lift height*1

Up to **4978kg**
Static tipping load

Up to **143hp**
Engine power

up to **40 km/h**



MLA
Articulated Loader
with parallel linkage *2



MLA
Articulated Loader
with z-bar linkage *3



MLA-T
Articulated Loader
with telescope *4

*1 Max lift height with pallet forks.

*2 On MLA 1-25 H, MLA 3-35 H, MLA 4-50 H.

*3 On MLA 5-50 H-Z, MLA 6-65 H-Z, MLA 7-75 H-Z.

*4 On MLA-T 516-75 H, MLA-T 533-145 V+.



COMFORT A PLEASANT WORKING ENVIRONMENT

You will feel good...

- Adjustable door opening (3 positions)
 - Adjustable steering column*¹
 - Adjustable operator seat
 - Adjustable armrest
- Flat floor for optimal leg room
 - 12V plug
- Multi-function joystick

*¹ Except on MLA 1-25 H.

You have the choice

Depending on models, you have the choice between different types of operator station configurations:

- 2-post open canopy (incl. FOPS protection) *²
 - 4-post open canopy *³
- 4-post open canopy with front and rear windows *⁴
- Enclosed cab *⁵: supplied as standard with heating, and also available with optional air conditioning *⁶

*² On MLA 3-35 H, MLA 4-50 H, MLA 5-50 H-Z.

*³ On all models except MLA-T 533-145 V+.

*⁴ On MLA 6-65 H-Z, MLA 7-75 H-Z and MLA-T 516-75 H.

*⁵ On all models except MLA 1-25 H and MLA 4-50 H.

*⁶ Except on MLA 3-35 H.



2-POST



4-POST



CAB



MLA-T 533

360° visibility

The central cab location, the sloping rear bonnet and the 4 work lights give the operator 360° visibility, night and day. The high-mounted seat provides an excellent vantage point to the attachment.



MLA 7 + BS bucket

Easy entry

The wide door(s) opening and the anti-slip step(s) are perfectly adapted to frequent entry and exit of the operator station.

PERFORMANCE

ALL TERRAIN MANOEVRABILITY

Differential lock on front and rear axles*1

Maximum traction, even on muddy ground.

45° articulation

The excellent turning radius optimises cycle times and enables the machine to work in the most confined spaces. No need for complicated manoeuvres, a turn of the wheel is all that is needed to pick up your load!

Boom suspension (optional)

This system absorbs the shocks when driving with or without a load. The components are put under less strain, your load is protected and drive comfort is ensured.



Oscillation*2

Even on rough terrain, the oscillation allows tyre to ground contact to be maintained at all times.

High ground clearance
(up to 39 cm)

Mudguards

Agricultural
profile tyres

4 wheel drive

*1 Except on the MLA-T 533-145 V+ (front axle only).

*2 Located on the articulation, except on the MLA-T 533-145 V+ (on rear axle).

from
86cm
overall width



MLA 5 + BS bucket



MLA-T 533 + CBA bucket



MLA 7 + BS bucket

ITOU

Transmission adapted to your working environments

Hydrostatic transmission*1

The hydrostatic transmission enables you to adapt the travel speed up to 30 km/h*2 and to adapt the tractive effort according to the task. Choose your speed with a simple push directly from the joystick. Precision and tractive power: the hydrostatic transmission guarantees smooth handling.

*1 On all models except MLA-T 533-145 V+

*2 Optional depending on models

M-Vario Plus transmission*3

Reach 40 km/h smoothly and without changing gear! This continuous variable transmission (CVT) consists of two hydraulic motors powered by a hydraulic pump. At low speeds, the two motors are active. The tractive power is therefore comparable to that of a torque converter transmission. At high speeds, only one motor is active. The maximum speed is reached with no loss of energy so that a high tractive power is retained. Fuel consumption is optimized and the sound pollution caused by the transmission is reduced. The M-Vario Plus combines precision and performance and is a pleasure to use, even for the most inexperienced users.

*3 On MLA-T 533-145 V+.



MLA-T 533 + P2BG bale clamp

Inching feature
This function combines low speed approach with fast hydraulic movements, perfect for bale stacking.



MLA-T 533 + P2BG bale clamp

Vari drive
With the use of the accelerator pedal, the user can adjust his moving speed independently from the engine RPM set by the hand throttle.



MLA 5 + SCA sweeper



MLA 7 + BS bucket



PERFORMANCE DESIGNED TO LAST

Robust design

Built with robustness in mind, all manitou articulated loaders include the following features:

- Central articulation locking bar (for transport)
- ROPS / FOPS*¹ compliant work station
- Large skid plate protecting the engine area
- Road lights*² recessed into counterweight or bumper

*¹ Rollover protection systems / Falling object protection systems.

*² Standard on MLA-T 533-145 V+. Optional on the other models.

Auto reversing fan*³

When the automatic reversing fan function is engaged, the fan can be temporarily reversed to eject debris from the coolers. Cooling is always optimal, especially in very dusty environments such as straw and chicken manure handling.

*³ Standard on MLA 6-65 H-Z, MLA 7-75 H-Z, MLA-T 516-75 H.

PERFORMANCE

CREATE FREE TIME FOR OTHER TASKS

FLOW
SHARING*1

Up to
158 l/min

HIGH
FLOW
OPTION*2

*1 On MLA-T 533-145 V+ only

*2 On MLA 6-65 H-Z, MLA 7-75 H-Z and
MLA-T 516-75 H only

Easy to transport

The MLA 1-25 H and MLA 3-35 H can easily be transported on a trailer. No need to organize or pay for a specific transport saving time and money!

1,500 dealers at your service

With presence across more than 120 countries, the Manitou network of dealers guarantees a full portfolio of support services at all stages of your machine life – to assist you with everything from acquisition to after-sales.

Use your equipment with peace of mind: opt in either for a warranty extension or for a maintenance contract (preventive and/or curative maintenance) tailored to your needs. Rely on more than 7,000 expert technicians and original spare parts to maintain your equipment, maximise its performance and preserve its lifespan for an optimum resale value.

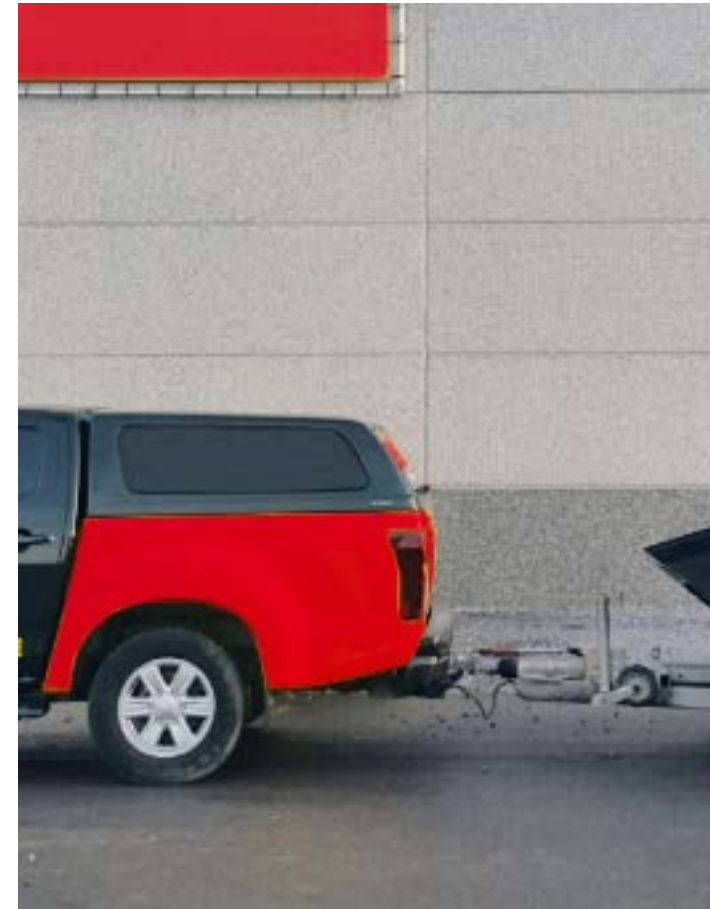

Attachments can be changed in seconds

With the attachment carriage, attachments can be changed within seconds. The ECS (Easy Connect System) decompresses the hydraulic attachment line without turning off the engine, making it quick and easy to change your hydraulic attachments.





MLA 3 + BS bucket

Intelligent Hydraulics (optional)*1

Quick lift: automatically allows two simultaneous movements (raising/lowering + extension/retraction) and facilitates stocking operations.



Bucket shaker: quickly empties the bucket without requiring the operator to make repetitive movements. Manure will no longer stick to the bottom of the bucket.

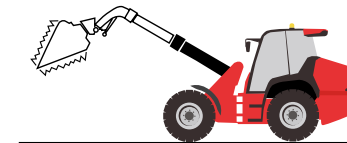

Automatic return to load: to easily return to a position (attachment and boom) pre-determined by the operator. This function is particularly useful for loading operations.



MLA 3 + trencher *2



MLA 3 + SCB sweeper



MLA-T 533 + CBA bucket

Regenerative Hydraulics (optional)*1

This system makes it possible to lower the boom, regardless of engine speed, using gravitational force. Save time and fuel on every boom lowering manoeuvre.

*1 Available on MLA-T 533-145 V+ only.
*2 Specific request.

COST EFFICIENCY

OUR PRIORITY:
MAKING YOUR LIFE
EASIER

Intelligent maintenance*1

The dashboard screen notifies the driver of possible errors. It gives your dealer useful information to rapidly intervene.

*1 On all models except on the MLA 1-25 H.



MLA 5



MLA-T 533



MLA-T 533

Easy access to the main components

Because you have no time to lose, we have engineered the MLA to make maintenance easy:

- Wide engine hood opening
- Removable side panels*2
- Tilttable cab*3
- Centralized position of greasing points

*2 On MLA 6-65 H-Z, MLA 7-75 H-Z, MLA-T 516-75 H.

*3 On MLA 1-25 H, MLA 3-35 H, MLA 4-50 H.



Smart connected machines ^{*1}



Get real time information about your equipment and usage at your fingertips - on your mobile or customized platform.

Monitoring

Connect your Manitou for warranty compliance and monitoring: allow the technician to contact you ahead of the preventive maintenance to agree on a convenient time for a visit; allow remote diagnostics and troubleshooting to facilitate the dispatch of a technician with the right parts - improving the first-time fix rate and maximising equipment uptime.

Control

Control the performance thanks to real time monitoring and secure your equipment with geofencing capabilities: receive alerts via sms, email and pop up messages - in case of any unplanned movement or activity.

Peace of mind

Your equipment is monitored continuously for performance and faults and technicians are dispatched to deal with issues requiring human intervention. You can save time and effort, focus on your core activity and let us manage the rest!

Totally Customer Oriented

Our teams are committed to bringing innovative solutions and continuous improvements to reduce your TCO (Total Cost of Ownership)^{*2}. Try our user friendly tools to assess your own TCO: understand your direct and indirect costs and use the results to select the most appropriate solution in the range that will guarantee performance, peace of mind as well as resale value.

Making good decisions starts right here – try the www.reduce-program.com calculator and valuable tips

^{*1} Available on all machines except MLA 1-25 H, MLA 3-35 H, MLA 4-50 H, MLA 5-50 H-Z.

^{*2} TCO what is it? The Total cost of ownership (TCO) of an asset is the calculation of the running cost. TCO takes into consideration fixed costs such as acquisition, interest, rent, residual value etc., and variable costs linked to the use of your machine, such as maintenance, user training etc. every cost from purchase to end of life.





TO EACH HIS OWN... STYLE

Choose from a wide range of articulated loaders with different dimensions, capacities, lift heights... You also have the choice among various options, attachments and finish levels to best suit your needs.



Technical features



MLA 1-25 H^{*2}

Transmission	-	Hydrostatic
Engine power	hp	24
Environmental norm	-	Stage IIIA
Engine brand	-	Yanmar
Max. payload with forks as per EN 474-3 (80%)	kg	N/A
Static tipping load with bucket (straight)	kg	875
Max. lift height (below forks)	m	2.50
Max. bucket hinge pin height	m	2.71
Ground clearance	m	0.19
Dimensions without attachment (WxLxH)	m	0.86x2.74x2.19
Hydraulic pump	-	Gear pump
Hydraulic flow	l/min	30
Unladen weight (with forks)	kg	1744
Max. travel speed	km/h	13



MLA 3-35 H^{*1}

Transmission	-	Hydrostatic
Engine power	hp	35
Environmental norm	-	Stage IIIA
Engine brand	-	Yanmar
Max. payload with forks as per EN 474-3 (80%)	kg	N/A
Static tipping load with bucket (straight)	kg	1670
Max. lift height (below forks)	m	2.65
Max. bucket hinge pin height	m	2.86
Ground clearance	m	0.24
Dimensions without attachment (WxLxH)	m	1.32x3.35x2.48
Hydraulic pump	-	Gear pump
Hydraulic flow	l/min	45
Unladen weight (with forks)	kg	2472
Max. travel speed	km/h	19



MLA 4-50 H^{*1}

Transmission	-	Hydrostatic
Engine power	hp	47
Environmental norm	-	Stage IIIA
Engine brand	-	Yanmar
Max. payload with forks as per EN 474-3 (80%)	kg	N/A
Static tipping load with bucket (straight)	kg	1839
Max. lift height (below forks)	m	2.77
Max. bucket hinge pin height	m	3.01
Ground clearance	m	0.25
Dimensions without attachment (WxLxH)	m	1.33x3.55x2.54
Hydraulic pump	-	Gear pump
Hydraulic flow	l/min	57
Unladen weight (with forks)	kg	2740
Max. travel speed	km/h	20

*1 With 2-post opened canopy (with FOPS protection).

*2 With 4-post opened canopy.

MLA 5-50 H-Z*1

Transmission	-	Hydrostatic
Engine power	hp	47
Environmental norm	-	Stage IIIA
Engine brand	-	Yanmar
Max. payload with forks as per EN 474-3 (80%)	kg	N/A
Static tipping load with bucket (straight)	kg	2151
Max. lift height (below forks)	m	2.86
Max. bucket hinge pin height	m	3.06
Ground clearance	m	0.27
Dimensions without attachment (WxLxH)	m	1.33x3.79x2.54
Hydraulic pump	-	Gear pump
Hydraulic flow	l/min	57
Unladen weight (with forks)	kg	3307
Max. travel speed	km/h	20

*1 With 2-post opened canopy (with FOPS protection).

*2 With 4-post opened canopy.

MLA 6-65 H-Z*2

Transmission	-	Hydrostatic
Engine power	hp	65
Environmental norm	-	Stage IIIB
Engine brand	-	Yanmar
Max. payload with forks as per EN 474-3 (80%)	kg	N/A
Static tipping load with bucket (straight)	kg	2907
Max. lift height (below forks)	m	3.13
Max. bucket hinge pin height	m	3.32
Ground clearance	m	0.37
Dimensions without attachment (WxLxH)	m	1.65x4.26x2.47
Hydraulic pump	-	Gear pump
Hydraulic flow	l/min	70
Unladen weight (with forks)	kg	4150
Max. travel speed	km/h	30



MLA 7-75 H-Z*2

Transmission	-	Hydrostatic
Engine power	hp	74
Environmental norm	-	Stage IIIB
Engine brand	-	Deutz
Max. payload with forks as per EN 474-3 (80%)	kg	N/A
Static tipping load with bucket (straight)	kg	3378
Max. lift height (below forks)	m	3.28
Max. bucket hinge pin height	m	3.47
Ground clearance	m	0.31
Dimensions without attachment (WxLxH)	m	1.74x4.44x2.48
Hydraulic pump	-	Gear pump
Hydraulic flow	l/min	70
Unladen weight (with forks)	kg	4781
Max. travel speed	km/h	30

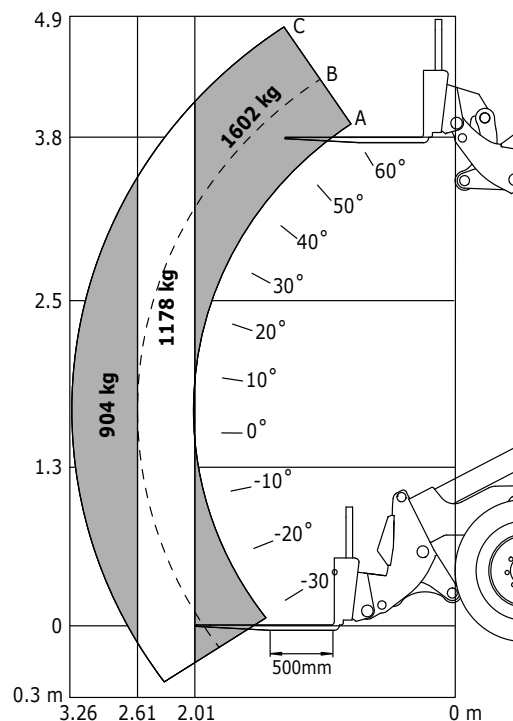

MLA-T 516-75 H*2

Transmission	-	Hydrostatic
Engine power	hp	74
Environmental norm	-	Stage IIIB
Engine brand	-	Deutz
Max. payload with forks as per EN 474-3 (80%)	kg	1600
Static tipping load with forks (straight)	kg	N/A
Max. lift height (below forks)	m	4.84
Max. bucket hinge pin height	m	5.03
Ground clearance	m	0.31
Dimensions without attachment (WxLxH)	m	1.74x4.95x2.48
Hydraulic pump	-	Gear pump
Hydraulic flow	l/min	70
Unladen weight (with forks)	kg	5543
Max. travel speed	km/h	30



According to EN 474-3 (80%)



MLA-T 533-145 V+

-	M-Vario Plus
hp	143
-	Stage IV
-	Deutz
kg	3300
kg	4978
m	5.20
m	N/A
m	0.39
m	2.29x5.72x2.70
-	Load Sensing pump
l/min	158
kg	8430
km/h	40

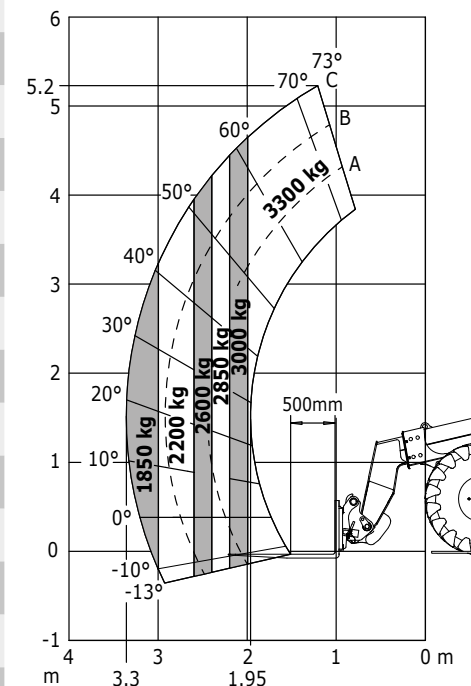

According to EN 474-3 (80%)

*2 With 4-post opened canopy.























4 finish levels

 **ESSENTIAL**
 **CLASSIC**
 **PREMIUM**
 **ELITE**

s : standard / o : option / - : not available

	MLA 1-25 H	MLA 3-35 H		MLA 4-50 H	MLA 5-50 H-Z		MLA 6-65 H-Z		
									
General									
Manual hand throttle	-	S	S	S	S	S	S	S	S
Air prefilter	S	S	S	S	S	S	S	S	S
Speed control	-	-	-	-	-	-	O	O	S
Third gear	-	-	-	-	-	-	O	O	S
Comfort									
Canopy	S	S	-	S	S	-	S	-	-
Enclosed cab with heating	-	-	S	-	-	S	-	S	S
Tuner car radio	-	-	S	-	-	S	-	S	S
Bluetooth car radio with integrated microphone	-	-	-	-	-	-	-	-	-
Bluetooth car radio with extra microphone	-	-	-	-	-	-	-	-	-
Adjustable steering column	O	S	S	S	S	S	S	S	S
Air conditioning	-	-	-	-	-	O	-	O	S
Mechanical seat	S	S	S	S	S	S	S	S	-
Air suspension seat	-	-	-	O	-	O	-	O	S
Low frequency air suspension seat	-	-	-	-	-	-	-	-	-
Boom suspension	-	-	-	-	-	-	O	O	S
Floor mat	-	-	S	-	-	S	S	S	S
Electricity / Safety									
Complete road lights	O	O	S	O	O	S	O	S	S
Rotating beacon	-	O	O	O	O	O	O	O	O
Front and rear work lights on cab (x4)	-	S	S	S	S	S	S	S	-
Front and rear LED work lights on cab (x4)	-	-	-	-	-	-	O	O	S
Electric mirrors with de-icing	-	-	-	-	-	-	-	-	-
Hydraulics									
Attachment hydraulic line	S	S	S	S	S	S	S	S	S
Easy Connect System (ECS)	-	S	S	S	S	S	S	S	S
Attachment hydraulic locking	O	O	O	O	O	O	S	S	S
Continuous flow hydraulics	S	S	S	S	S	S	S	S	S
Intelligent Hydraulics	-	-	-	-	-	-	-	-	-
Regenerative Hydraulics	-	-	-	-	-	-	-	-	-

MLA7-75 H-Z			MLA-T 516 -75 H			MLA-T 533-145 V+		
								
S	S	S	S	S	S	S	S	S
S	S	S	S	S	S	S	S	S
0	0	S	0	0	S	S	S	S
0	0	S	0	0	S	-	-	-
S	-	-	S	-	-	-	-	-
-	S	S	-	S	S	S	S	S
-	S	S	-	S	S	S	-	-
-	-	-	-	-	-	0	S	-
-	-	-	-	-	-	0	0	S
S	S	S	S	S	S	S	S	S
-	0	S	-	0	S	0	S	S
S	S	-	S	S	-	S	-	-
-	0	S	-	0	S	0	S	-
-	-	-	-	-	-	0	0	S
0	0	S	0	0	S	0	0	S
S	S	S	S	S	S	S	S	S
0	S	S	0	S	S	S	S	S
0	0	0	0	0	0	S	S	S
S	S	-	S	S	-	S	-	-
0	0	S	0	0	S	0	S	S
-	-	-	-	-	-	0	0	S
S	S	S	S	S	S	S	S	S
S	S	S	S	S	S	S	S	S
S	S	S	S	S	S	0	0	0
S	S	S	S	S	S	0	0	S
-	-	-	-	-	-	0	0	S
-	-	-	-	-	-	0	S	S

Full range of tyres

You can choose between different tyre treads, brands and dimensions so that it is completely customised to your environment.



Attachment hydraulic locking (optional)

The attachment hydraulic locking allows you to change and lock the attachment without leaving the cab.



Homologated attachments

Versatility

Your daily operations are characterized by a great diversity. The articulated loader range offers much versatility with a wide range of attachments: moving grain, stacking hay bales, cleaning the yard, removing snow...



Grain buckets

Designed for all non-coherent materials with a density of less than 1000 kg/m³: grain, mineral feed, poultry manure etc.



Standard buckets

THE universal bucket for all heavy bulk materials. Available with optional teeth or bolt-on wear plate *¹.



Grapple buckets

The "must have" attachment for feed, silage and manure handling.



Round bale clamps

Powerful and rugged clamps for all round bales. Can also handle square ones *¹.



Wrapped bale clamps

For handling both round and square bales, the perfect solution to move bales without film damage - hence ensuring optimal profitability *¹.



Bale forks

Simple and efficient bale handling solutions.

*¹ Subject to compatibility limitations. Check with your Manitou dealer.



4 in 1 buckets

Load, dig and push with one single attachment. Available with and without teeth *1.

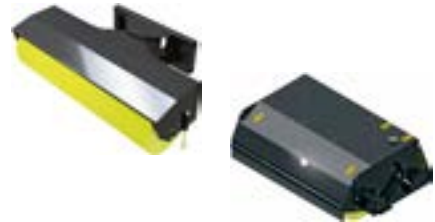

Sweepers

To keep your farm yard clean.

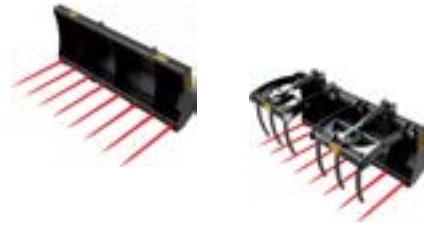

Farm forks & grabs

Attachments dedicated to the handling of heavy, compact manure. Can also be used for silage pit preparation and occasional bale handling *1.



Snow & dozer blades

Whatever the material, our blades will offer competitive solutions and make work easy.

**Choose between
a full range of
attachment carriages**

- Manitou attachment carriage
- 4-point attachment carriage*1
- All-Tach attachment carriage *2
- Power-A-Tach attachment carriage *1
- Euro 8 attachment carriage*1
- Pin&Cone attachment carriage *3

*1 On all models except MLA-T 533-145 V+.

*2 On MLA 1-25 H, MLA 3-35 H, MLA 4-50 H, MLA 5-50 H-Z.

*3 On MLA-T 533-145 V+ only.



A range of services



- **Dealership network**
A network of experts at your service, whatever your field (agriculture, construction, industry).
- **Maintenance contracts**
Three levels of contract that are tailored to your needs: Initial, Advanced and Excellence. Entrust the maintenance of your equipment to your dealer.
- **Manitou Finance**
Tailor-made solutions: Whatever your business, simplify your investment with Manitou Finance financing or leasing solutions.
- **Warranty extension**
With Maniplus, you can extend the cover of your Manitou for up to 5 years. Use your equipment with peace of mind.
- **Connected solution**
Manage, optimise and protect your machine: with the connected solution, you have the right information at the right time, to help you make the right decision!
- **Second-hand**
In the market for second-hand equipment? The Manitou network is here to help. Just visit your dealer or used.manitou.com, our reference site for second-hand Manitou machines.
- **Original spare parts**
With more than 70,000 products available, your Manitou agent provides expertise and service on a daily basis!



Your dealer:



Head office

B.P. 249 - 430 rue de l'Aubinière - 44158 Ancenis Cedex - France

Tel.: 00 33 (0)2 40 09 10 11 - Fax: 00 33 (0)2 40 09 10 97



This publication provides the description of the versions and configuration possibilities of Manitou products, which may differ in terms of equipment. The equipment presented in this brochure may be available as part of a series, available as an option, or not available, depending on the versions. Manitou reserves the right, at any time and without notice, to amend the specifications described and represented. The specifications provided do not bind the manufacturer. For more details, please contact your Manitou agent. This is not a contractually binding document. The presentation of the products is not contractually binding. The list of specifications is non-exhaustive. The logos and visual identity of the company are the property of Manitou and cannot be used without authorisation. All rights are reserved. The photos and diagrams in this brochure are only provided for consultation and information purposes. Manitou BF SA - Limited company with board of directors. Share capital: 39,668,399 euros - 857 802 508 RCS Nantes